

Whimsical Star Pouf Ottoman

By Susan Guzman, SuzGuz Designs

www.SuzGuzDesigns.com



Enjoy this exciting new pattern where you'll make a playful star pouf ottoman. This design will add a touch of whimsy to your living space.

Finished Size: 15"L x 20"W

Sewing Supplies:

- Any HUSQVARNA VIKING® sewing machine
- INSPIRA® Quilting size 90 needles 620100296
- TrueCut Ruler 24.5"L x 6.5"W quilter's ruler 700000301
- TrueCut Rotary Cutter 143100015
- TrueCut Cutting Mat 18" x 24" 143100020

- **Fabric Requirements:** Fabrics used should be at least 54"W decorator weight, except for the lining fabric, Fabric 2.
 1. Fabric 1 (cream floral print) for top and sides: 1 yard
 2. Fabric 2 (cream or white solid) for lining: 1 yard
 3. Fabric 3 (green stripe) for bottom: $\frac{5}{8}$ yard
 4. Fabric 4 (green swirl print) for star top: $\frac{1}{2}$ yard
 5. Fabric 5 (orange swirl print) for star top: $\frac{1}{2}$ yard
 6. Fabric 6 (multi-stripe) for star top: $\frac{1}{2}$ yard
 7. Fabric 7 (orange geometric print) for star top: $\frac{1}{2}$ yard
 8. Batting: 36"L x 54" W
 9. Pom-pom trim: 3 yards
 10. Stuffing material (consider old, unused, clean blankets, towels, rags, or fabric scraps).

- **Thread**
 - 1 large spool of 40 wt. 100% cotton thread

- **Sewing Supplies**
 1. Printer/paper for templates
 2. Straight pins
 3. Scissors
 4. Marking pencil
 5. Heavy-duty needle and thread for hand sewing
 6. Iron
 7. Ironing board

Prepare:

- Layer Fabric 1, batting, and Fabric 2; baste. Quilt layers together.

- Print and tape together Template 1 and Template 2.

Cut:

From quilted Fabric 1 unit (Diagram 1):

- Cut two rectangles, 32³/₈"L x 16"W.
- Using Template 1 and pencil, trace onto the Fabric 2 side of the quilted fabric unit, then cut out Template 1 circle.

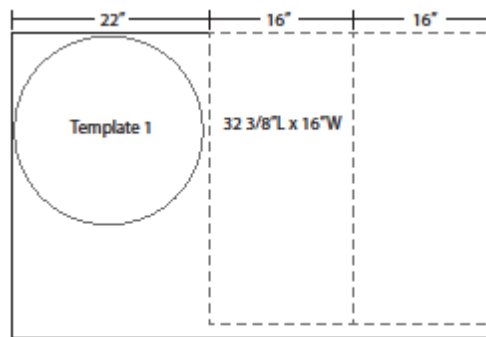

Diagram 1

From Fabric 3:

- Using Template 1 and pencil, trace onto wrong side of fabric and cut out circle shape.

From each, Fabrics 4-7:

- Using Template 2 and pencil, trace 4 times onto wrong side of fabric and cut out diamond shapes.

Sew:

Use 1/2" seam allowance.

Make pouf base:

- With right sides together, sew Fabric 1 rectangles together along 16" width. Press seam open. Flip unit over, with right side facing up and sew 1/4" on either side of seam to secure seam allowance.
- Repeat the same process on the opposite 16"W edges, making a tube, and leaving an approximate 9" opening in the center to be used for stuffing. Press seam open and sew 1/4" on either side of seam to finish (Diagram 2).

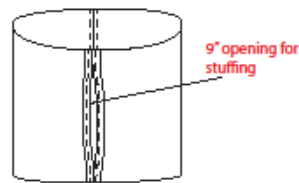

Diagram 2

- With wrong side of tube facing out and with right sides together, pin your Fabric 1 quilted circle completely around top edge of the tube; sew together (Diagram 3).

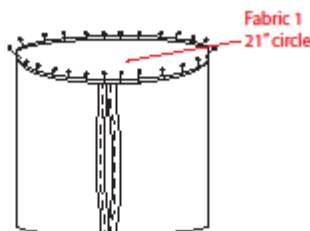
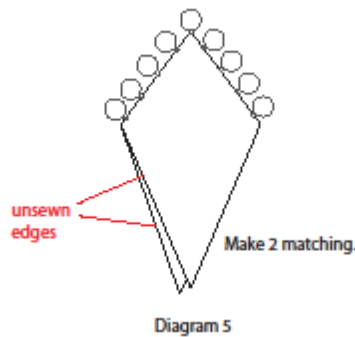
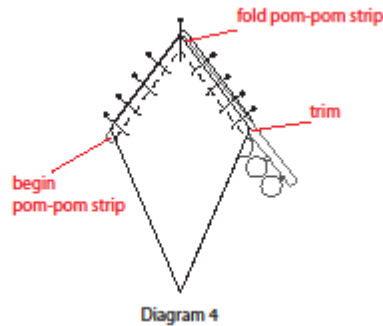

Diagram 3

- Using the same process, take your Fabric 3,(21”) circle, and pin right sides together around circumference; sew completely along outside edge.
- Turn unit right sides out through 9” opening of tube and set aside.

Make star diamond units:

- Select 2 matching Fabric 4 diamond shapes. With right sides together, pin a length of pom-poms between the two short sides of the diamond shapes; pom-poms facing in aligning raw edges (Diagram 4). Trim unused pom-poms even with side. Sew along both short edges to secure pom-poms in place. Make 2 matching units (Diagram 5).



- In the same manner, make 2 matching units each, using Fabrics 5, 6, and 7. Assemble diamond units into star:

- Lay out 1 diamond/pom-pom unit, each (Fabrics 4-7). Sew together into a half-circle unit and press seams open (Diagram 6).

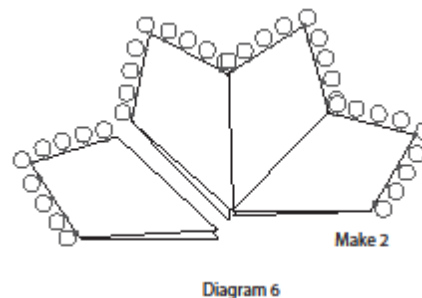

- Lay out remaining diamond/pom-pom units in the same order and sew together into a half-circle unit; press seams open.
- Sew both half-circle units together; press seams open (Diagram 7).

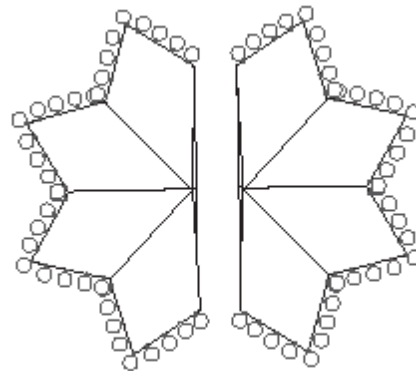

Diagram 7

Hand-sew star to top of pouf base:

- Center star on top of pouf base; pin in place.
- Using heavy-duty thread and needle, tack down star seam allowances to pouf base at center and on outer edge of star where each diamond unit meets.

Finishing Pouf

Using clean stuffing materials, stuff into 9” opening of pouf. Over-stuffing your pouf is a good thing! When finished stuffing, use a blind stitch to hand-sew the opening closed.

Congratulations! Your pouf is finished! We hope you enjoy many relaxing moments using your new pouf ottoman. Make several to be used as extra seating when entertaining guests.